

VIAMI

Optical Component Environmental Test System

The Certified VIAMI OCETS (Optical Component Environmental Test System) is the third generation of the classic OCETS, a solution customers have relied on for almost 30 years. With improved hardware specifications and software algorithms, the Certified VIAMI OCETS meets the latest market requirements for optical component qualification testing, such as those driven by the Verizon FOC program.

All standards require that a representative number of sample devices be subjected to a program of environmental stresses. Stress types include dwelling at high and low temperatures while maintaining target humidity levels, and cycling between temperatures. For example, an environmental test program can consist of numerous temperature and humidity pairings along with a series of mechanical tests. Device characteristics must be measured before and after each stage in the test program and, in some cases, continuously or at various intervals during a particular stage. Removing all the devices from the environmental chamber for optical measurements is simply not practical, and it is for this measurement requirement that the Certified VIAMI OCETS has been designed.



Benefits

- High Return Loss option (HiRL) monitors RL up to 70 dB
- Up to 320 device channels (640 ports)
- High insertion loss (IL) and return loss (RL) repeatability
- Full bidirectional testing
- Single-mode and multimode systems
- Supplied with EasyOCETS software

Applications

- Unattended long term monitoring of optical component IL and RL
- Measures parameters required in Telcordia standards such as GR-326-CORE, GR-910-CORE, GR-1435-CORE, GR-1209-CORE and GR-2866-CORE
- Verizon FOC qualification for components such as Jumpers, Cables, and Passive Splitters

Safety Information

- Complies to CE requirements. Switch and MAP based products comply to UL3101.1 and CAN/CSA-C22.2 No. 1010.1. MAP lasers are Class 1 except for 850 nm version which is Class 1M. The lasers are classified per IEC standard 60825-1(2002) and comply with 21CFR1040.10 except deviations per Laser Notice No. 50, July 2001.

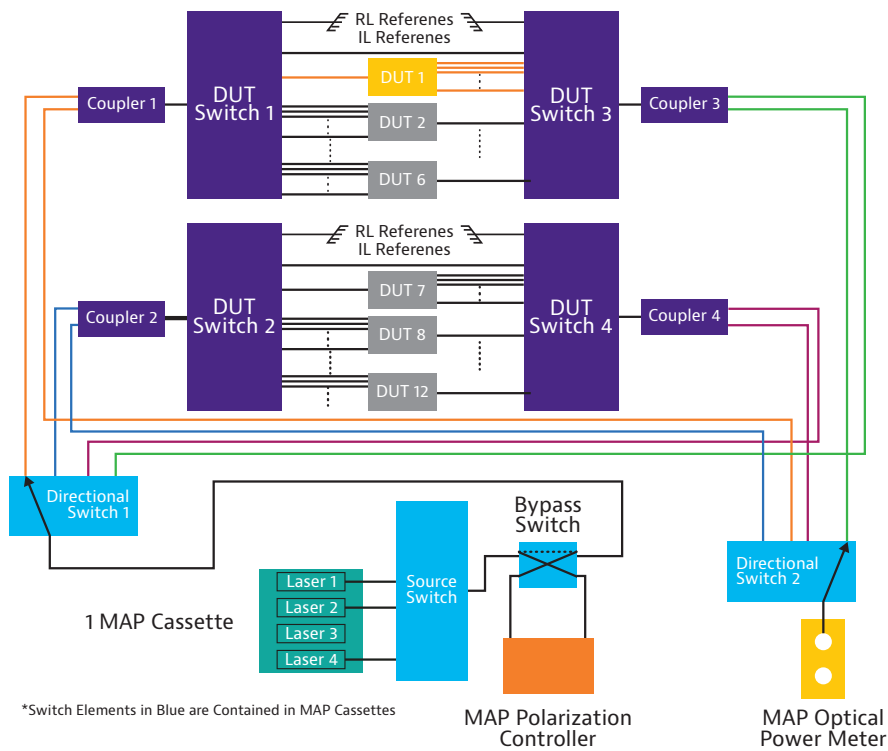

1676.900.1123

Figure 1. Bidirectional Test Configuration of 1x32 splitters, within a 320 channel (640 port) system

Optical Performance

The Certified VIAVI OCETS uses Super Luminescent Diodes (SLEDs)—carefully engineered light sources providing high power and short coherence length—to maximize overall system performance while maintaining strict adherence to wavelength and bandwidth standards. Minimizing coherence length is critical to long-term stability; however, the broad wavelength coverage can bias test results. To minimize bias, each SLED is individually filtered to create the ideal long-term test source.

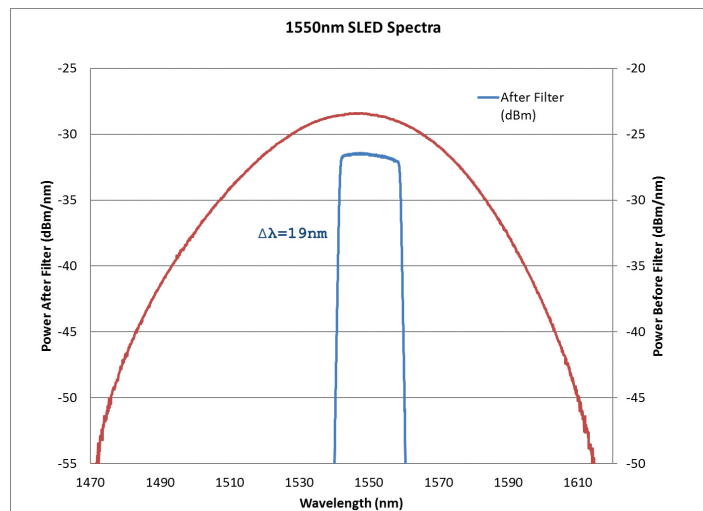

For 30 years, VIAVI (and its former heritage as JDSU) has been the leader in optical switching for test and measurement applications. At the core of the Certified VIAVI OCETS is a pair of third-generation optical switches that are based on the MAP-200 MISW-C1 Optical Switch solution. The ultra-low loss and repeatability of these switches are key to the performance of the system. Specifically designed with beam traps to capture stray light, the MISW-C1 Optical Switch solution is optimized for return-loss stability.

The following examples of Insertion Loss and Return Loss in simple loopback mode demonstrate the system stability.

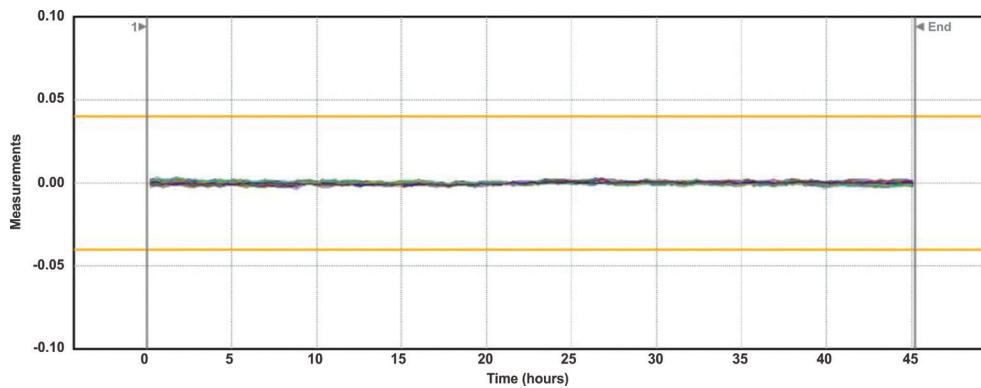

Figure 2. Insertion Loss

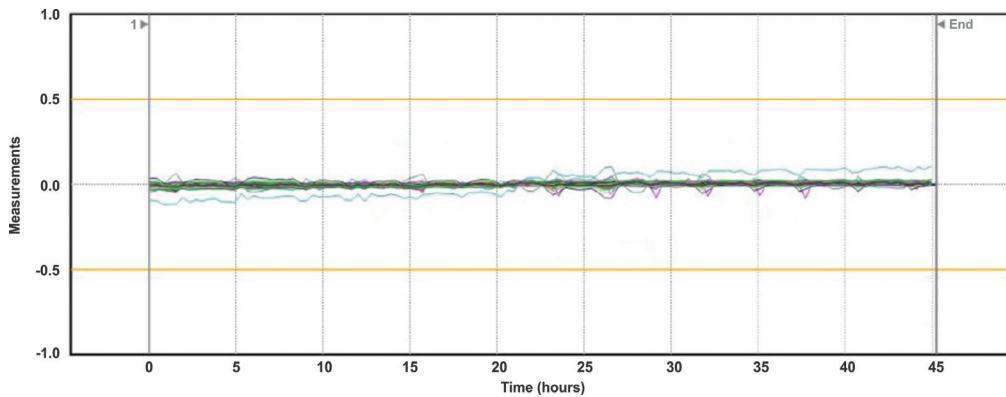
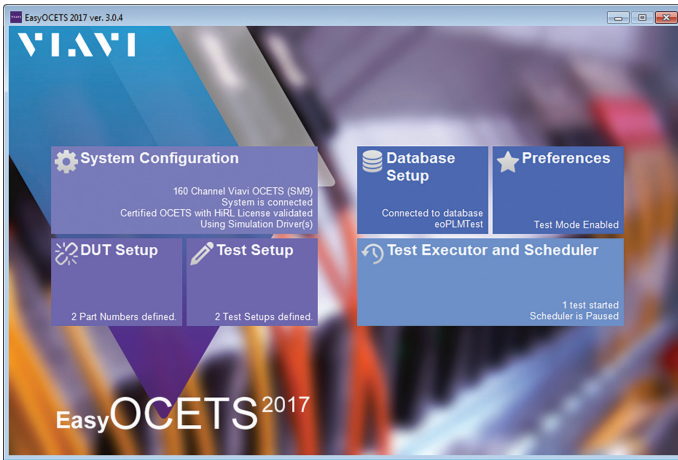

Figure 3. Return Loss

EasyOCETS2017 and EasyViewer 2017 Software

The VIAVI OCETS comes with two independent software packages. EasyOCETS2017 is the main control and data-collection interface. EasyViewer 2017 enables viewing and extraction of the data. Data is collected in an SQL database that can be remotely hosted anywhere on your network. All test files, DUT definitions and system configuration files are in the SQL database and can be shared between systems.

The Test Executor and Scheduler has been dramatically improved to allow multiple tests to be scheduled at the same time and provide greater flexibility for large-channel-count systems.



Simple, clear interface makes checking status or training new operators fast and efficient. Tool sets for adding setup instructions make creating tests simple and efficient. Central database allows data to be accessed anywhere and test scripts to be programmed remotely.

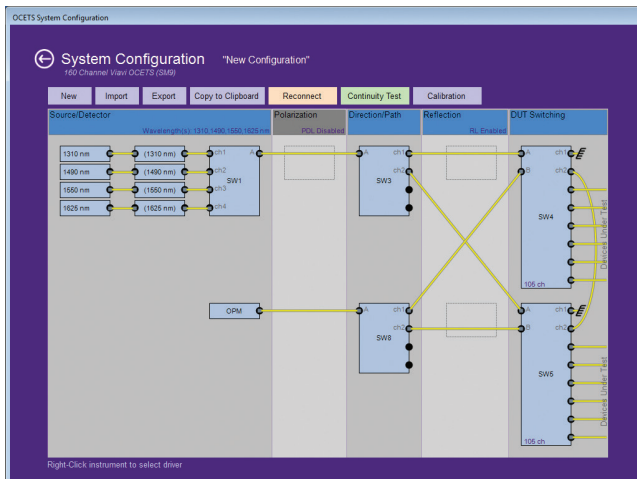

Visual guide to the test system is simple and intuitive. Simulation and continuity-check modes simplify set up.

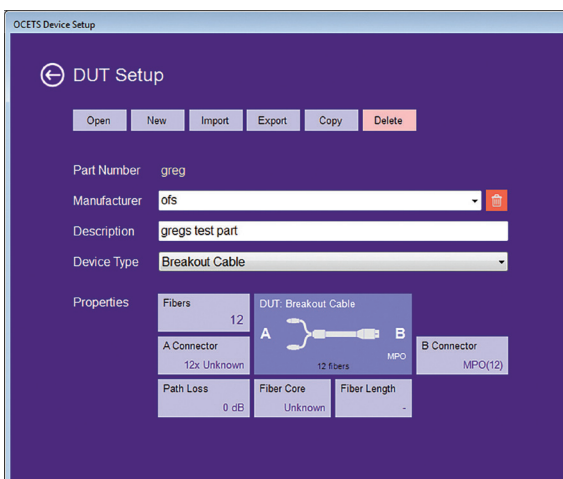

Device under test (DUT) libraries are created using a simple editor. Auto-channel-connection algorithms simplify creating test scripts.

Specifications

Parameter	Single-Mode (SM)	Multimode (MM)
Fiber Type	9/125 μ m fiber, standard 3 mm jacket	50/125 μ m fiber, standard 3 mm jacket
SC Switch Pigtail Lengths (to DUTs)	5 m per switch (10 m total between the two switches)	5 m per switch (10 m total between the two switches)
Insertion Loss (IL) dynamic range	>65 dB	>50 dB
Insertion Loss (IL) repeatability over 100 hours	± 0.04 dB for IL <50 dB	± 0.04 dB for IL <35 dB
Return Loss dynamic range	>70 dB	>35 dB
Return Loss (RL) repeatability over 100 hours	± 0.4 dB up to 55 dB With HiRL option: ± 1 dB up to 65 dB ± 3 dB up to 70 dB	± 0.4 dB up to 30 dB
Measurement Timing	IL, RL, HiRL <2.5 s ¹	IL, RL <2 s
Sources Available ²	1310, 1490, 1550, 1625 ± 10 nm SLED	850, 1300 ± 20 nm LED ³
Source Power Stability at 23°C	± 0.01 dB for 20 minutes	± 0.01 dB for 15 minutes
General		
Number of Channels ⁴	55, 105, 160, 210, or 320 input and output channels	
Number of Reference Channels ⁵	1 IL path, 1 RL path (per DUT switch)	
Equipment Warm-Up Time	4 hours, can be left on indefinitely with no adverse side effects	
Input Voltage	100V to 240V AC, 50/60 Hz auto-switching	
Power Consumption (includes computer)	55 to 160 channels: 750 VA; 210 to 320 channels: 950 VA	
Computer Control	Minimum configuration: Intel Core i3 CPU, 8GB RAM, 500GB HDD, 2 x 10/100G Ethernet interface, USB 2.0 port	
Mechanical Configuration	All equipment, except computer, is installed in a single bay, 32U, 19-inch rack with removable covers and door Cabinet includes top-mounted fans, casters and levelers W x H x D: 22 x 72 x 26 in (56 x 183 x 66 cm) Rear door access to MAP cassettes	
Weight	55 to 160 channels: 190 kg; 320 channels: 220 kg	
Operating Humidity	0 to 80% RH range. Maximum variation range during a test: 15% RH	
Operating Temperature	15 to 30°C range. Maximum variation within range during a test: 3°C	

Available Configurations

OCETS is available in 55, 105, 160, 210 or 320 channel configurations. Systems can be supplied with either FC/APC bulkhead connectors on the DUT switches, or with 10-meter unterminated pigtails. Single Mode systems have the option of High Return Loss (HiRL). The HiRL option is only available for systems supplied with 10-meter unterminated pigtails.

1. Averaged over 60 consecutive measurements, not including reference or saving to database.

2. Source stability is measured at full power, constant current mode in a controlled environment of 23 \pm 1°C.

3. Multimode launch conditions meet the requirements of IEC 61280-4-1 Ed. 2.0.

4. The number of channels refers to the number of input and output channels; for example, "55 channels" means 55 input and 55 output channels.

5. The RL reference as utilized in the EasyOCETS2017 software algorithms is a 0 dB reflector. Users may add RL references to other ports.

In addition, as many input and output ports as required for IL references can be utilized.

Part Numbers

Fiber Type	Measurements	Test Channels	System Part Number
Standard Single-mode	Insertion Loss and Standard Return Loss	55	MOCETS-A4055S0-M100-MXX
		105	MOCETS-A4105S0-M100-MXX
		160	MOCETS-A4160S0-M100-MXX
		210	MOCETS-A4210S0-M100-MXX
		320	MOCETS-A4320S0-M100-MXX
50um Multimode EF Compliant		55	MOCETS-A4055S0-M101-MXX
		105	MOCETS-A4105S0-M101-MXX
		160	MOCETS-A4160S0-M101-MXX
		210	MOCETS-A4210S0-M101-MXX
		320	MOCETS-A4320S0-M101-MXX
Standard Single-mode	Insertion Loss and High Return Loss	55	MOCETS-A4055H0-M100-MNC
		105	MOCETS-A4105H0-M100-MNC
		160	MOCETS-A4160H0-M100-MNC
		210	MOCETS-A4210H0-M100-MNC
		320	MOCETS-A4320H0-M100-MNC

When MXX is shown, the following options are available

MXR CODE	CONNECTOR TYPE
MFA	FC/APC
MNC	No Connectors



Contact Us **+1 844 GO VIAMI**
(+1 844 468 4284)

To reach the VIAMI office nearest you,
visit viavisolutions.com/contact

© 2023 VIAMI Solutions Inc.
Product specifications and descriptions in this document are subject to change without notice. Patented as described at viavisolutions.com/patents/opticalcomponents-ocets-ds-fop-nse-ae
30186399 903 1123